

CANDY

User Manual Dishwasher

CFP 4D9F0W-80
CFP 4D9F0B-80



EN

Safety and warnings	2
Installation instructions	6
Product Description	14
Control Panel	15
Programme	18
First use	19
Loading suggestions	20
Setting a wash	21
Delayed start	23
Keylock	24
Preferences	25
Water softening system	26
Detergent	28
Rinse aid	30
Daily Use	31
Maintenance	34
Troubleshooting	39
Fault codes	42
Standards Test	43
Technical Data	44

Intended Use

The appliance is designed for domestic use inside the house, or in similar applications such as staff kitchen areas in working environments, farm houses, by clients in hotels, motels or other residential environments, and bed and breakfast environments. It is not intended for commercial or industrial use. Do not use it for purposes other than that for which it was designed.

Changes or modifications to the device are not allowed. Unintended use may cause hazards and loss of warranty claims.

Standards and Directives

This product meets the requirements of all applicable EC directives with the corresponding harmonised standards, which provide for CE marking.

Read and save this guide

When using your Dishwasher, follow basic precautions, including the following:

General

- ▶ The information in this guide must be followed to minimise the risk of fire or explosion or to prevent property damage, personal injury or loss of life.
- ▶ Use the Dishwasher only for its intended function as described in this guide.
- ▶ This appliance is intended to be used in household and similar applications such as:
 - staff kitchen areas in shops, offices and other working environments
 - farm houses
 - by clients in hotels, motels and other residential environments
 - bed and breakfast environments.
- ▶ Use only detergents or rinse aid recommended for use in a domestic dishwasher and keep them out of reach of children. Check that the detergent dispenser is empty after the completion of each wash program.
- ▶ When loading items to be washed, locate sharp items so that they are not likely to damage the Dishwasher and load sharp knives with the handle up to reduce the risk of cut injuries.
- ▶ Do not touch the filter plate in the Dishwasher base during or immediately after use, as it may be hot.
- ▶ Do not operate your Dishwasher unless all enclosure panels are properly in place.
- ▶ Do not tamper with the controls.
- ▶ Do not abuse, sit on, stand in or on the door or dish rack of the Dishwasher.
- ▶ The door should not be left in the open position since this could present a tripping hazard.

- ▶ Do not lean on or use the foldaway cup racks to support your body weight.
- ▶ To reduce the risk of injury, do not allow children to play in or on the Dishwasher.
- ▶ Under certain conditions, hydrogen gas may be produced in a hot water heater system that has not been used for two weeks or more. **HYDROGEN GAS IS EXPLOSIVE.** If the hot water system has not been used for such a period, before using the Dishwasher, turn on all hot water taps and let the water flow from each for several minutes. This will release any accumulated hydrogen gas. As the gas is flammable, do not smoke or use an open flame during this time.
- ▶ Remove the door to the washing compartment when removing an old Dishwasher from service or discarding it.
- ▶ Some dishwasher detergents are strongly alkaline. They can be extremely dangerous if swallowed. Avoid contact with the skin and eyes and keep children away from the Dishwasher when the door is open.
- ▶ The Dishwasher must be used with the filter plate, filter, and spray arms in place. To identify what these parts are refer to 'Maintenance'.
- ▶ If the Dishwasher is not being used for long periods of time, turn the electricity and water supply off.
- ▶ Cleaning and maintenance shall not be done by children without supervision.
- ▶ Take care not to load dishware items so they prevent the door from closing.
- ▶ Household appliances are not intended to be used by children. Children of less than 8 years old must be kept away from the appliance unless continuously supervised. This appliance can be used by children aged from 8 years and above, and persons with reduced physical, sensory or mental capabilities or lack of experience and knowledge, if they have been given supervision or instruction concerning the use of the appliance in a safe way and they understand the hazards involved. Children being supervised not to play with the appliance.
- ▶ If a dishwasher cleaner is used, we recommend running a wash program with detergent immediately afterward to prevent any damage.
- ▶ The Dishwasher is designed for washing normal household utensils. Items that are contaminated by petrol, paint, steel, iron debris, corrosive, acidic or alkaline chemicals are not to be washed in the Dishwasher.
- ▶ Do not wash plastic items unless they are marked dishwasher safe or equivalent. For plastic items not marked, check the manufacturer's recommendations.
- ▶ Avoid washing containers with glued on labels. Labels removed during a wash cycle may cause damage to the wash system

Installation

- ▶ This Dishwasher must be installed and located in accordance with the Installation instructions before it is used. If you did not receive Installation instructions with your Dishwasher, you can order them by calling your Authorised Repairer or download them from our local Haier website, listed on the back cover.
- ▶ Installation and service must be performed by a Haier trained and supported service technician.
- ▶ If the power supply cord is damaged, it must be replaced by a Haier trained and supported service technician or a qualified trades person in order to avoid a hazard.
- ▶ Ensure the Dishwasher is secured to adjacent cabinetry using the brackets provided. Failure to do so may result in an unstable product, which may cause damage or injury.
- ▶ Do not operate this appliance if it is damaged, malfunctioning, partially disassembled or has missing or broken parts, including a damaged power supply cord or plug.
- ▶ Do not store or use petrol, or other flammable vapours and liquids in the vicinity of the Dishwasher.
- ▶ Connect to a properly rated, protected and sized power supply circuit to avoid electrical overload.
- ▶ Ensure the power supply cord is located so that it will not be stepped on, tripped over or otherwise subject to damage or stress.
- ▶ Do not install or store the Dishwasher where it will be exposed to temperatures below freezing or exposed to weather.
- ▶ Do not use an extension cord or a portable electrical outlet device (e.g. multi-socket outlet box) to connect the Dishwasher to the power supply.
- ▶ This appliance must be grounded. In the event of a malfunction or breakdown, grounding will reduce the risk of electric shock by providing a path of least resistance for electric current.
- ▶ This appliance is equipped with a cord having an equipment-grounding conductor and a grounding plug. The plug must be plugged into an appropriate outlet that is installed and grounded in accordance with all local codes and ordinances. Improper connection of the equipment-grounding conductor can result in a risk of electric shock. Check with a qualified electrician or Haier trained and supported service technician if you are in doubt as to whether the appliance is properly grounded.
- ▶ Do not modify the plug provided with the appliance; if it will not fit the outlet, contact a Haier trained and supported service technician or qualified electrician.
If the Dishwasher is installed as a permanently connected appliance, this appliance must be connected to a grounded metal, permanent wiring system, or an equipment-grounding conductor must be run with the circuit conductors and connected to the equipment-grounding terminal or lead on the appliance.

Maintenance

- ▶ Disconnect the appliance from the power supply before any cleaning or maintenance.
- ▶ When disconnecting the appliance pull the plug rather than the power supply cord or junction of cord to avoid damage.
- ▶ Do not repair or replace any part of the appliance or attempt any servicing unless specifically recommended in this guide. We recommend contacting a Haier trained and supported service technician or Customer Care.
- ▶ Keep the floor around your appliance clean and dry to reduce the possibility of slipping.
- ▶ Keep the area around/underneath your appliance free from the accumulation of combustible materials, such as lint, paper, rags and chemicals.



WARNING!

Any installation may be carried out only by a qualified technician refer to section SAFETY.

Free Standing Installation

Install the appliance on solid ground. Adjust all feet accurately to get a firm, horizontal position.



Only with a correct level the appliance door closes and seals correctly.

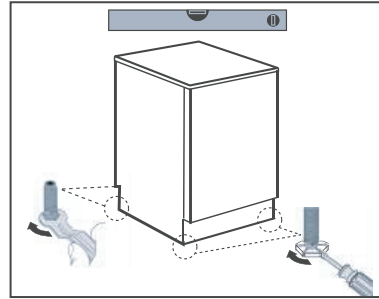

Installation under Worktop

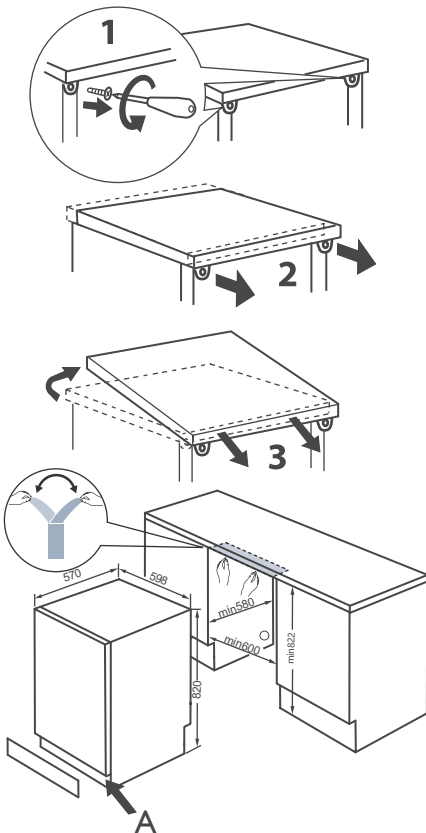

1. Optional: Remove the worktop of the appliance.
2. Adjust all feet accurately to get a firm level position.
3. Stick the water-proof sticker on the bottom of the countertop.
4. Install the appliance carefully into the recess.



WARNING!

If used as free standing appliance again, the worktop must be remounted.

5. The dimensions of the recess should at least agree with the dimensions in the figure.
6. After installation, the minimum gap between the side panel and the cupboard is 1mm, and the minimum gap between the rear and the cupboard is 10mm. The top gap is controlled by adjusting the feet.
7. Put the appliance adjacent to the slot. Make sure that all connections (water, drain water, power) are neatly positioned and connected.
8. Cotton bottom felt need to be added as shown in figure A to ensure the noise effect

Fresh Water Connection

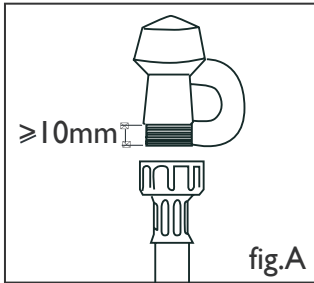

IMPORTANT!

- ▶ The appliance should be connected to the water main using the new water inlet hose supplied. Old hoses should not be used.
- ▶ Do not shorten the inlet hose.

1. Take note of water connection requirements.
 - ▶ The dishwasher has a single valve water connection.
 - ▶ We recommend a cold water connection for best performance and energy efficiency.
 - ▶ The incoming water temperature should not exceed 25°C.
2. Take note of the permitted water pressure extremes.
 - ▶ Lowest: 0.3 bar = 3 N/cm² = 0.03MPa
 - ▶ Where pressure is below 1 bar, contact a qualified plumber.
 - ▶ Highest: 10 bar = 100 N/cm² = 1MPa
 - ▶ Where pressure is above 10 bar, a pressure reduction valve must be installed. Contact a qualified plumber.
3. Connect the water inlet hose to an accessible water tap with a 3/4" BSP connector (see fig.A). Ensure that there is no kink in the inlet hose that could restrict the flow of water. A 90° bend requires a minimum height of 200 mm for a kink-free curve.
 - ▶ Ensure incoming water is clear. If the water pipes have not been used for a long period of time, let the water run to make sure it is clear with no impurities. Not doing so may result in the water inlet hose getting blocked and damaging the appliance.
 - ▶ If required, use a filter insert to filter out deposits from the piping. The filter insert is available from your Authorised Service Centre or Customer Care.
4. Tighten the hose coupling a further half turn after seal contact.
5. Check that the connection does not leak.

Drain Water Connection

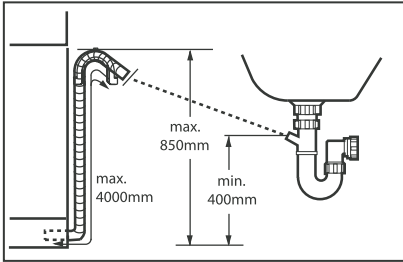

Fix the water drain hose properly to the piping. The hose has to reach at one point a height between 400 and 850 mm above the appliance bottom line.

An extension hose for the water drain hose must not exceed a total length of 4 m and must have the same diameter as the water drain hose.

Following connections are possible:

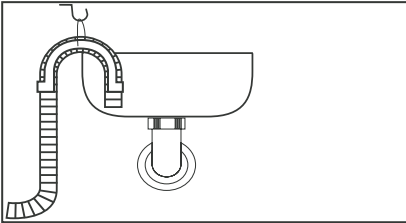

Drain hose to sink

- ▶ Hang the drain hose with the U-support over the edge of a sink with adequate size.
- ▶ Protect the U-support sufficiently against slipping.

Drain hose to waste water connection

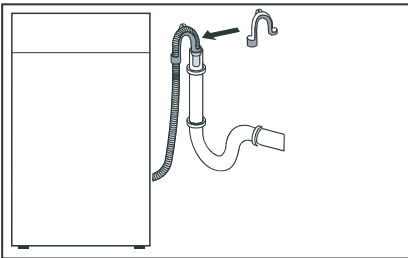

- ▶ The internal diameter of the stand pipe with vent-hole must be minimum 40 mm.
- ▶ Put the drain hose for approx. 80 mm in the wastewater pipe.
- ▶ Attach the U-support and secure it sufficiently.

Drain hose to sink connection

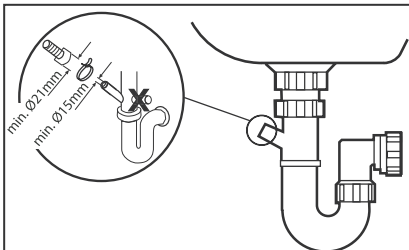

- ▶ When connecting the drain hose to a sink trap with a drain hose spigot, make sure that the drain hose is supported to the height of the bench.
- ▶ Ensure the drain spigot has a minimum hole diameter of 15 mm and it has been drilled out.

Power connection

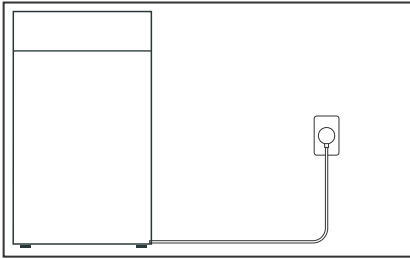

As shown in the figure, the power supply is plugged into an externally accessible place through the service hole for easy plugging.



CAUTION!

Always ensure that all connections (power supply, drain and fresh water hose) are firm, dry and leak free.

Take care that these parts are never to be crushed, kinked, or twisted. If the supply cord is damaged, it must be replaced by the manufacturer, its service agent or similarly qualified persons in order to avoid a hazard.

Service hole

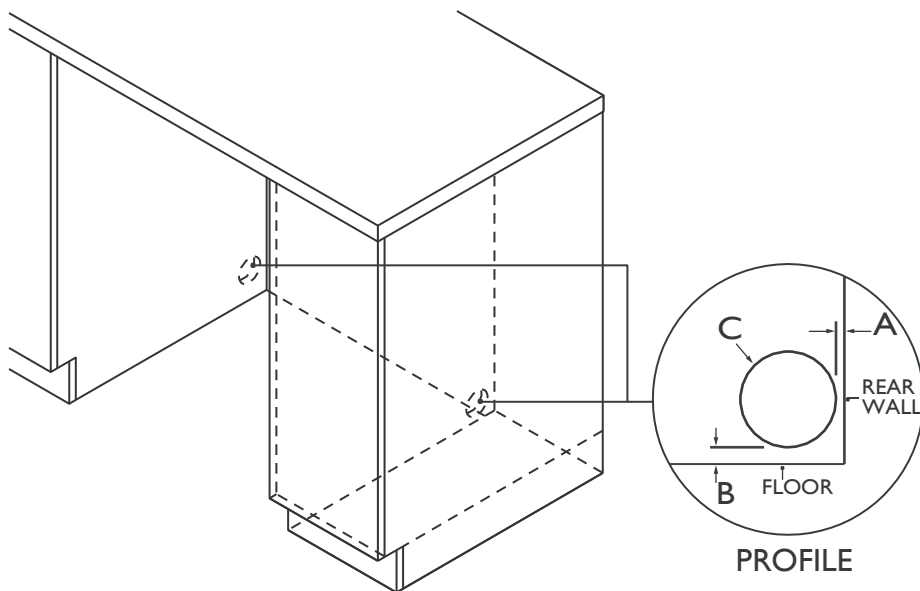

Service hole dimensions	mm
A Maximum distance between rear of cavity and service hole*	15
B Maximum distance between floor and service hole**	50
C Minimum diameter of service hole	70

* based on a cabinetry depth of 580mm.

**depending on adjustment of levelling feet.

Connect inlet hose to cold water

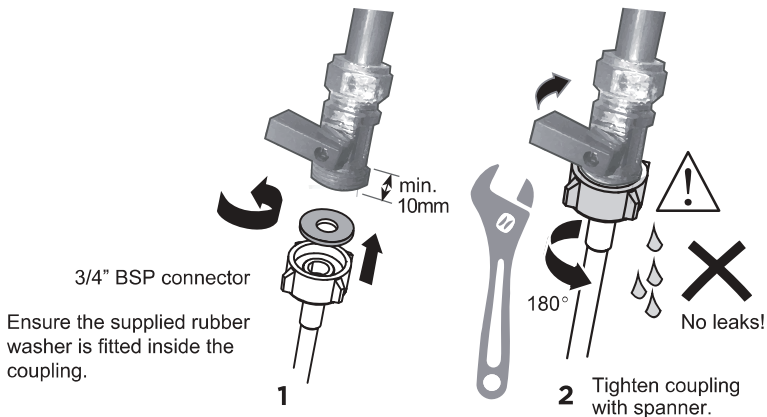

Plumbing -- Water inlet connection

IMPORTANT!

- **The appliance should be connected to the water main using the new water inlet hose supplied. Old hoses should not be used.**
- **Do not shorten the inlet hose.**

1. Take note of water connection requirements.
 - The dishwasher has a single valve water connection.
 - We recommend a cold water connection for best performance and energy efficiency.
 - The incoming water temperature should not exceed 25°C.
2. Take note of the permitted water pressure extremes.
 - **Lowest:** 0.3 bar = 3 N/cm² = 0.03MPa
 - Where pressure is below 1 bar, contact a qualified plumber.
 - **Highest:** 10 bar = 100 N/cm² = 1MPa
 - Where pressure is above 10 bar, a pressure reduction valve must be installed. Contact a qualified plumber.
3. Connect the water inlet hose to an accessible water tap with a 3/4" BSP connector. Ensure that there is no kink in the inlet hose that could restrict the flow of water. A 90° bend requires a minimum height of 200mm for a kink-free curve.
 - Ensure incoming water is clear. If the water pipes have not been used for a long period of time, let the water run to make sure it is clear with no impurities. Not doing so may result in the water inlet hose getting blocked and damaging the appliance.
 - If required, use a filter insert to filter out deposits from the piping. The filter insert is available from your Authorised Service Centre or Customer Care.
4. Tighten the hose coupling a further half turn after seal contact.
5. Check that the connection does not leak.

Plug product in



Electrical connection

- The dishwasher must not be connected to the electrical supply while installation is being carried out. Ensure all domestic wiring is properly earthed.
- Check the rating label (located on the left-hand side of the dishwasher's stainless steel inner door) and ensure that the voltage and frequency values for the current in the house correspond to those on the rating label.
- Insert the plug into a properly earthed power outlet that has a disconnection switch.

IMPORTANT!

- The earthing of the appliance is a safety requirement mandated by law.
- If the power cord is not long enough to reach the outlet or the outlet to which the appliance must be connected is not appropriate for the plug, the entire dishwasher power cord must be replaced. This should only be done by a Haier authorised technician. Do not modify or cut the plug. Do not use an adaptor, extension cord, or multi-outlet power board to connect the dishwasher to the power supply, as these could cause overheating and create a fire hazard.
- The outlet into which the dishwasher is plugged must remain easily accessible (e.g. in an adjacent cabinet) even when the appliance is installed. This is to ensure that the dishwasher can be disconnected from the power supply for safe cleaning and maintenance.

■ Final checklist

To be completed by the installer

- Check all parts are installed.
- Ensure that all panels and parts thereof are secure and final electrical tests have been conducted in accordance with local electrical regulations.
- Check that the dishwasher is level. If necessary, adjust the levelling feet slightly. To ensure optimum performance, the dishwasher should not be inclined more than 1°. Check with a spirit level.
- Ensure inlet hose to water supply has supplied rubber washer fitted, and that it's tightened a further half turn after seal contact.
- Ensure any knockouts or plugs in drain connection have been drilled out and drain connection has been made.
- The drain hose joiner must not support the weight of excess hose material. Keep drain hose as fully extended as possible to prevent sagging. Any excess length of drain hose should be kept on the dishwasher side of the highloop.
- If connecting the drain hose to the sink trap, ensure the Highloop is a minimum 150mm higher than the drain hose joiner.
- Ensure any packaging or tape securing the racks is removed from the dishwasher.
- Check that the door opens and closes freely without resistance to adjacent cabinetry.
- Check that the electrical outlet is accessible and located in an adjacent cupboard.
- Check the operation of the dishwasher:
If a fault code appears, see the 'Fault codes' section of the User guide for advice.

- ▶ Ensure the installer has completed the 'Final checklist' in the Installation instructions.
- ▶ Read this guide, taking special note of the 'Safety and warnings' section.
- ▶ Remove all internal and external packaging and dispose of it responsibly. Recycle items that you can.

Dishwasher overview

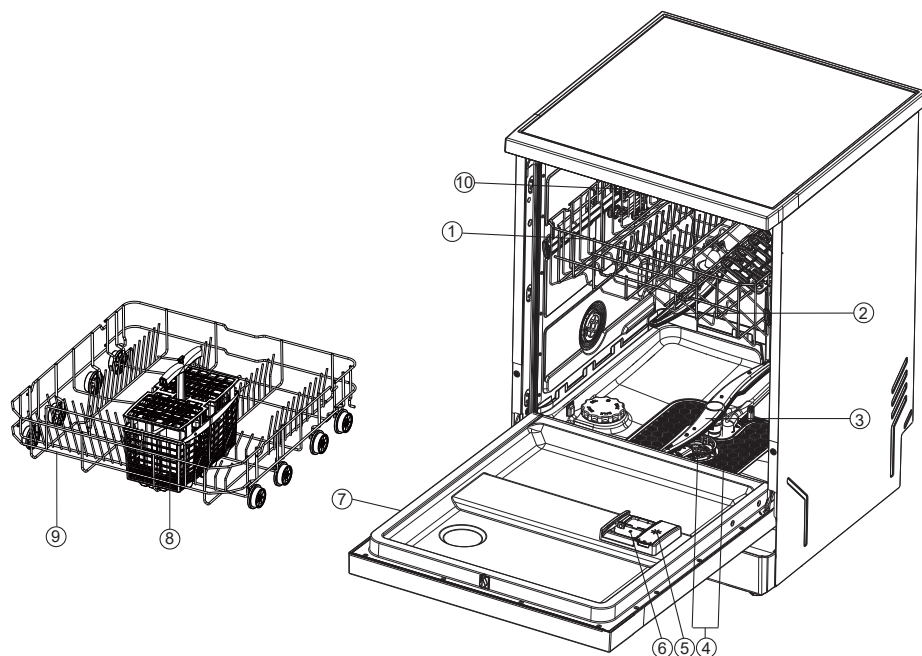

- | | |
|------------------------|---------------------------|
| 1. Upper basket | 6. Detergent dispenser |
| 2. Upper spray arm | 7. Rating label |
| 3. Lower spray arm | 8. Cutlery/Utensil basket |
| 4. Filte | 9. Lower basket |
| 5. Rinse aid dispenser | 10. Top spray arm |

Accessories

Check the accessories and literature in accordance with this list:



water inlet hose(1)

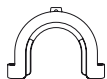

U-support(1)



User manual(1)

Safety guide(1)

Warranty card(1)



water-proof
sticker(1)



energy labels(2)

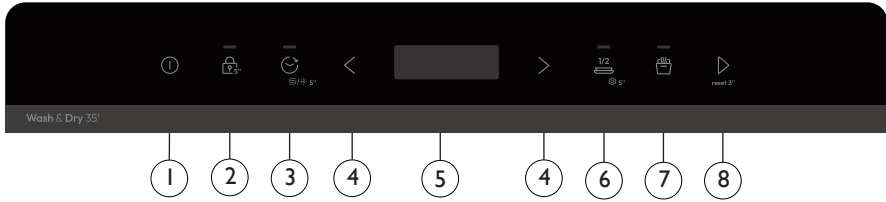

1. ON/OFF icon

2. Child Lock

3. Delay indicator icon

4. Programme select icon

5. Time&Info Display/Indicator icon

6. Half load indicator icon

7. Auto Door indicator icon

8. START/RESET icon

Time & Info display

During any selection the display shows related information like

- ▶ Programme cycle time
- ▶ Programme start delay time
- ▶ Error codes

After start of an operation it displays without flashing

- ▶ Remaining time in hours of a delayed programme starts, e.g. 24 H
- ▶ Remaining programme cycle time in hours + minutes, e.g. 1:59

While running it may vary due to local conditions and daily working load.

Indicator Icon

Salt aid



If the indicator lights up: Salt is empty.
Need to add salt.

Rinse aid



If the indicator lights up: Rinse is empty.
Need to add rinse aid.

Options description

Child Lock



Hold down the icon for 5 seconds to lock or unlock the option of other icons.

Delay



You can delay the start of a programme up to 24 hours.

Half load



Adjusts the wash program to more efficiently wash smaller loads.

Smart Door



Automatically open the door a few centimeters to allow air to circulate. Improve drying effect.

Reset



Hold down the icon for 5 seconds to reset the salt or rinse indicator light.

Tabs









Hold down the icon for 5 seconds to activate the user setting mode. Then you can activate the Tabs function. This option allows you to optimize the performance of the program by simply choosing the type of detergent you want to use.

The main program matched with the optional function.

WASH PROGRAM	Additional function
WASH&DRY 35'	Smart Door,Half load
59'MIN	Smart Door,Half load
ECO	Smart Door,Half load
UNIVERSAL	Smart Door,Half load
INTENSIVE	Smart Door,Half load
GLASS	Smart Door,Half load
PREWASH	-

Your dishwasher has a number of wash programs designed to suit your needs. Selecting the most appropriate cycle for each load will help ensure the best wash results.

Wash program	Program description
P1 WASH&DRY 35' 	Fast soil: Casseroles, sauces, potatoes, pasta, rice, roasted or fried food
P2 59MIN 	Use for dishes that are quite heavily soiled or food soils that have been left to dry overnight
P3 ECO 	For normally soiled dishes for optimum water and energy usage
P4 UNIVERSAL 	Best for dishes that are quite heavily soiled or to remove food soils that have been left to dry overnight
P5 INTENSIVE 	Designed for heavily soiled pots, pans and dishes
P6 GLASS 	Light soil: Coffee, cake, milk, cold drinks, salad, sausages
P7 PREWASH ¹⁾ 	Prevents odours and soils from dishes

1). Use this programme to quickly rinse the dishes. This prevents the remaining food to bond on the dishes and bad odours to come out from the appliance. Do not use detergent with this programme.

Dishware

The combination of high temperatures and dishwasher detergent may cause damage to some items. Refer to the manufacturer's guidance or wash by hand if in doubt.

Cutlery & silverware

Rinse cutlery and silverware immediately after use to prevent tarnishing. Silver should not come into contact with stainless steel, mixing these can cause staining. Remove silver cutlery from the dishwasher and hand dry immediately.

Aluminium

Aluminium can be dulled by detergent. The degree of change depends on the quality of the detergent or aluminium.

Other metals

Iron and cast iron can rust and stain other items. Copper, pewter and brass tend to stain.

Woodware

Woodware is generally sensitive to heat and water. Regular use in the dishwasher may cause deterioration over time.

Water hardness

Hard water is water with a high concentration of minerals such as calcium and magnesium. It can be detrimental to the performance of your dishwasher and parts can fail over time. Glassware washed in hard water will become cloudy over time and dishes will become spotted or covered in a white film. Water hardness varies by geographical location. If you live in a hard water area, we recommend fitting a water softener to the household water supply.

If your home has hard water

- Refer to 'Powdered detergent quantity recommendations'.
- Use rinse aid. We recommend you raise the rinse aid setting to help improve wash performance. Refer to 'Preferences' for details.

Use a dishwasher cleaner/descaler regularly, or whenever you notice a build-up of limescale deposits in your dishwasher.

If your home has soft or softened water

- Avoid using too much detergent.

Glassware

Most glassware is dishwasher safe. Crystal, very fine and antique glassware may etch and develop a cloudy appearance.

Plastics

Some plastics may change shape or colour with hot water. Refer to the manufacturer's guide. Dishwasher safe plastic should be weighed down so it does not flip and fill with water or fall through the base rack during the wash.

Decorated items

Most modern china patterns are dishwasher safe. Antique items, those with a pattern painted over the glaze, gold rims or hand painted china may be more sensitive to machine washing.

Glued items

Certain adhesives are softened or dissolved in machine washing.

When loading your Dishwasher ensure items are placed so water coming from the rotating spray arm below can reach all areas. Wash performance will be reduced if it can't.

Your dishwasher can hold up to a maximum of 11 place settings.

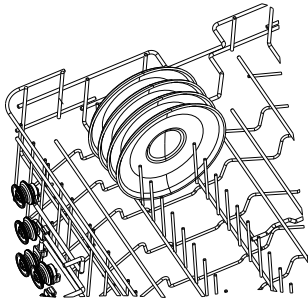

Ensure

- Lower and upper spray arms can rotate freely.
- Tall items do not obstruct the upper spray arm.
- Glass and other fragile items are stable.
- All dish openings are facing downwards.
- Plates are evenly spaced.
- All sharp objects are located securely to avoid injury or damage to the product.

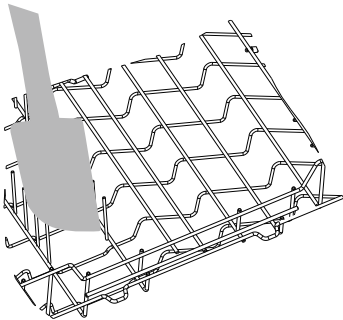

Avoid

- Overcrowding.
- Any protrusions below the racks and basket that may prevent spray arm rotation.
- Any protrusions at the front of the dishwasher.
- Blocking water from any items on the foldaway cup racks.

1

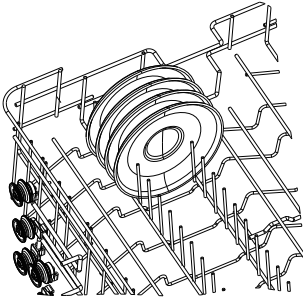

Remove all food scraps from dishware before carefully loading into the dishwasher. Ensure the spray arms are free from any obstructions and rotate freely.

2

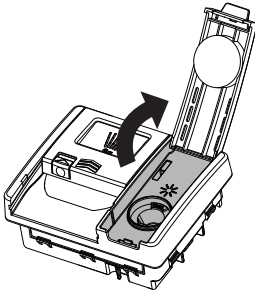

If the rinse aid indicator is illuminated, fill the rinse aid dispenser. Refer to 'Rinse aid' for additional guidance.

3

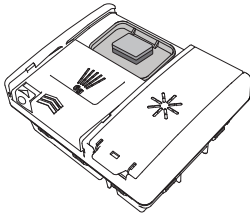



Add detergent to the dispenser and close the cover. Tablets can be placed in the detergent dispenser.

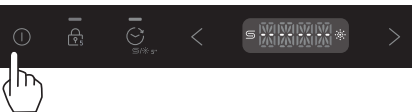

4

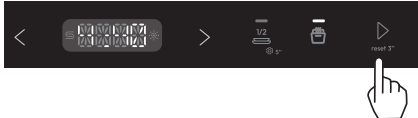

Make sure the dishwasher is powered on, press the  .

- 5  Select a wash modifier if required.

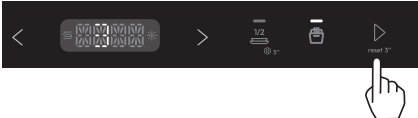
- 6  Close the door and press  to start the wash.

- 7  Press and hold  3 seconds to cancel.

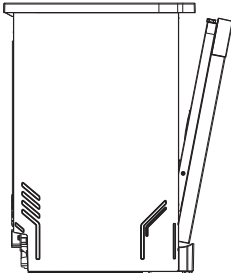
- 8  After the wash the door will automatically open slightly to assist with drying.*
For best results, unload dishes once cooled.
- * This function can be activated or not by the user.

Set your dishwasher to start later in the day and run a selected wash program. DELAYED START can be set after a wash program has been selected and can be set for up to 24 hours.

Setting Delayed Start

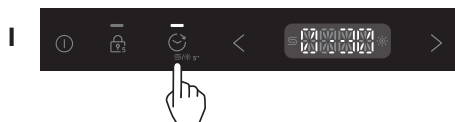

Add detergent and select a wash program, and wash modifier if required.

Press  to enter DELAYED START and increase the delay time.

*For the 0-4 hours, increase or decreases by 30min each press, and for 4-24 hours, increase or decreases by 1h.

Press  to confirm.

The wash program will begin at the end of the countdown, provided the door is closed.

* Open the door to pause DELAYED START. Close the door to continue.

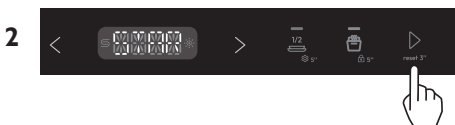

Cancelling Delayed Start

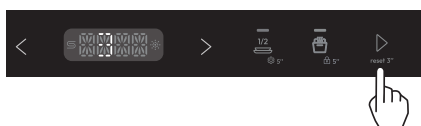

Open the door and press and hold  3 seconds to cancel.

Lock the dishwasher controls for cleaning or to prevent unintended use.

Locking the controls

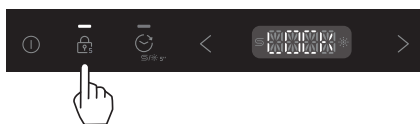

Press and hold  for 5 seconds to lock the dishwasher controls.

Note: Before locking the controls, running the program. After locking, except for the unlocking and turn off operation, other functions are not available.

Unlocking the controls

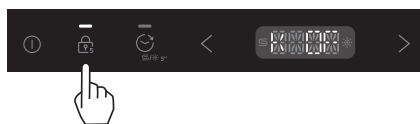

Press and hold  for 5 seconds to unlock.

You can adjust any of the below settings prior to starting a wash cycle.

Option	Description	Default	Settings display
LANGUAGE	Adjust according to the following page.	ENGLISH	LANGUAGE
TABLETS	Adjust according to the following page.	NO	TABLETS On YES Off NO
SOFTENER	Adjust according to the following page.	S 5	SOFTENER Min: S 0 Max: S 8
RINSE AID	Controls the amount of rinse aid dispensed. Refer to 'Rinse aid' for further details.	R 5	RINSE AID Min: R 0 Max: R 6
BUZZER	Adjusts tone settings. When set to NO all tones will be silenced except fault alerts.	YES	BUZZER On YES Off NO
LAST USED	Program memory function, select whether to remember the program last use.	NO	LAST USED On YES Off NO

Changing the setting

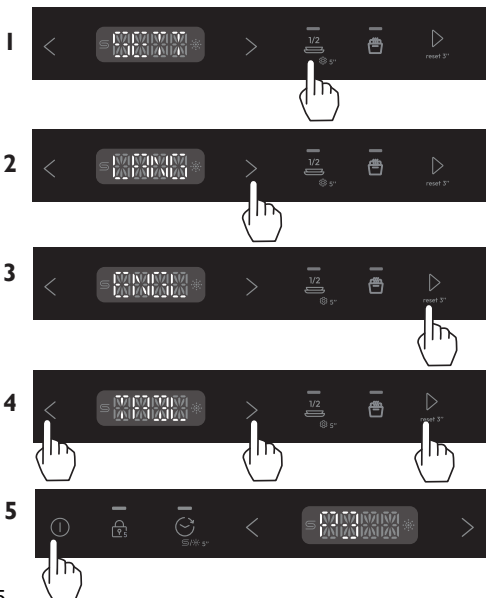

Ensure there is no wash in progress. Press and hold for 5 seconds to enter the menu.

Press to scroll through the settings.

Press to select the menu you want to adjust.

Press or to adjust the level. Press to save the settings.

Press to exit.

To ensure good washing results, the dishwasher requires soft water. Hard water can be detrimental to the performance of your dishwasher. Over time, glassware washed in hard water will become opaque and dishes will become spotted or covered in a white film. Using white film. Using very hard water can cause dishwasher parts to fail over time. Salt can improve the situation.

Adjusting the water softening system

The amount of salt dispensed can be set in S 0 and S 8 stages, depending on the hardness of your water.

1. Find out about the hardness value of your tap water. Your water utility company will help you with this.

2. Setting can be found in the water hardness table.

Identify the local water hardness

Water hardness				Water softener adjustment
German (°dH)	French (°fH)	Mmol/l	Clarke degrees	electronic
31-50	54-89	5,4-8,9	39-63	S 8
22-30	38-53	3,8-5,3	27-38	S 7
17-21	29-37	2,9-3,7	21-26	S 6
13-16	22-28	2,2-2,8	16-20	S 5 1)*
11-12	18-21	1,8-2,1	13-15	S 4
9-10	15-17	1,5-1,7	11-12	S 3
7-8	11-14	1,1-1,4	8-10	S 2
0-6	0-11	0-1,1	0-7	S 1 2)*
-	-	-	-	S 0 3)*

* Remark

- 1) Factory default setting for powder detergent.
- 2) Recommended setting for combi detergent tablets.
- 3) Indicator for Salt is off.

Using special salt

As soon as the low salt indicator is lit on the control panel ,salt should be topped up.Always refill with special salt immediately before switching on the appliance.This ensures that overrun special salt solution is immediately washed out and does not corrode the rinsing tank.

Top up the salt as follows:

▲ CAUTION

Only use dishwasher salt. Other products can cause damage to the appliance! Any spilled salt causes corrosion.Run a programme after each refill.

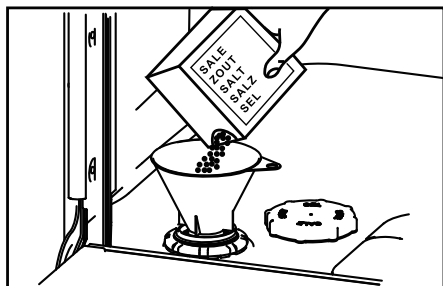

1. Turn the cap counter-clockwise to open the salt container.
2. Fill with 1 litre of water into the salt container.
3. Fill the tank up with specific salt (water overflows).
4. Remove spilled salt from the opening area.
5. Turn the cap clockwise to close the salt container.

WARNING: Dishwasher detergents are strongly alkaline. They can be extremely dangerous if swallowed. Avoid contact with the skin and eyes and keep children and infirm persons away from the dishwasher when it is open. Check the powdered detergent dispenser is empty after each wash.

Unsuitable detergents

These types of detergent are not suitable and may damage your dishwasher or lead to a service call that is not covered by warranty:

- ▶ Hand washing liquids
- ▶ Laundry detergents
- ▶ Soaps
- ▶ Disinfectants

Using powdered detergent

For powdered detergent quantities, refer to the following 'Powdered detergent quantity recommendations' table and the detergent manufacturer's guidance.

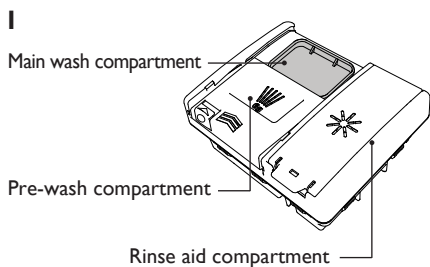

Check that the dispenser is empty and dry. Add powdered detergent or tablets to the detergent dispenser.

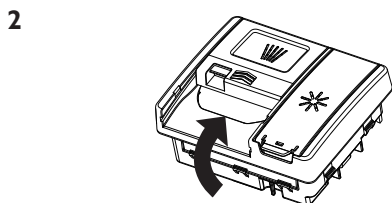







Remove any excess detergent then slide the cover closed. It will click into place. If required, add additional detergent to the pre-wash compartment on top of the dispenser.

When washing heavily soiled dishware in hard water, more detergent may be required. Refer to 'Powdered detergent quantity recommendations'.

Powdered detergent quantity recommendations

- ▶ Use the table below to determine the optimal powdered detergent quantity for each wash program.
- ▶ If you have hard water in your area, more detergent may be required.

Wash program	Pre wash compartment	Main wash compartment
P1 WASH&DRY 35'  35'	Full	15/25
P2 59MIN  59'	Full	15/25
P3 ECO  ECO 45°	Full	15/25
P4 UNIVERSAL  60°	Full	15/25
P5 INTENSIVE  75°	Full	15/25
P6 GLASS  45°	Full	15/25
P7 PREWASH 	None	None

Rinse aid provides a streak-free finish to glass and dishware as well as preventing metal from tarnishing. We recommend using a liquid rinse aid regularly for optimal drying results.

The rinse aid dispenser is located on the inside of the door next to the detergent dispenser.

Using rinse aid

The amount of rinse aid dispensed in each wash may need to be adjusted to suit your water conditions. Refer to 'Preferences' and 'Water hardness' for guidance. Rinse aid is not required if tablet has it already built into it.

1



When the rinse aid level is low, the rinse aid indicator on the control panel will light up to remind you to refill the dispenser.

2

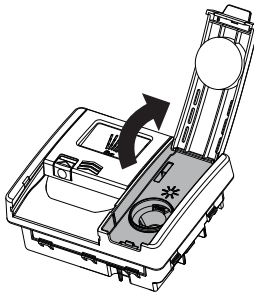

Lift the cover open and pour rinse aid into the opening.
Do not fill past the MAX line. Take care not to spill any onto the door or detergent bucket.

3

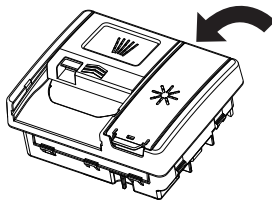

Close the cover, ensuring it clicks shut.

Any accidental spillages into the dishwasher or detergent bucket must be cleaned up immediately. Spilt rinse aid may result in excessive foaming. A service call relating to these errors will not be covered by warranty.

Load the Baskets



With delicate glasses and porcelain make sure they are labelled dishwasher-proof.

- × Do not put in the appliance items made of wood, horn, aluminium, pewter and copper.
- × Do not put in the appliance items that can absorb water (sponges, household cloths).
- ▶ Only use the appliance to wash items that are dishwasher-safe.
- ▶ Remove remaining food from the items.
- ▶ Soften burned food on the items before washing.
- ▶ Put hollow items (cups, glasses and pans) with the opening down.
- ▶ Put items with deep hollows in a slanted position.
- ▶ Mix spoons with other cutlery to prevent them to bond together.
- ▶ Make sure that cutlery and dishes do not bond together and there is a gap between each item.
- ▶ Make sure that glasses do not touch other glasses.
- ▶ Put small items in the cutlery basket.
- ▶ Put light items in the upper basket. Make sure that the items do not move.
- ▶ Make sure that the spray arms can move freely before you start a programme.



If jingling noises are heard during a programme run: Check that the dishes and glassware have a firm position.

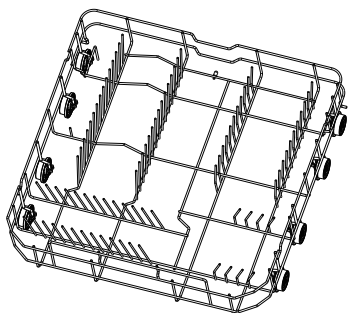

Place heavily soiled items (like pots and pans or dinner plates) in the bottom basket. The more powerful spray jet provides a better dishwashing result.

Upper baskets

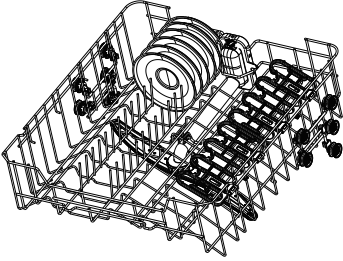

The upper basket is designed to hold items like glasses, cups, saucers, plates, small bowls and shallow pans.

Foldable cup racks

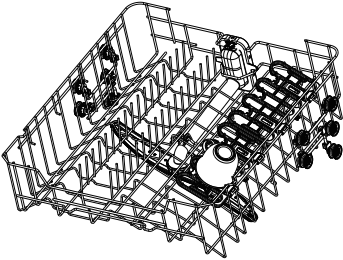

Adjust the height to suit or fold out of the way to make space for other items. Use the notches to support wine glass stems.

Folding and support can be achieved by flipping.

To adjust the upper basket.

Before you adjust its height, make sure the basket is empty.

Remove:

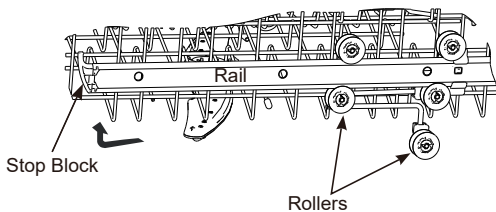

Replace:

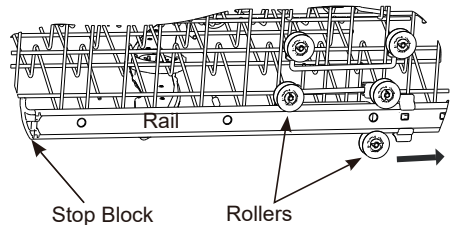

Cutlery/Utensil basket

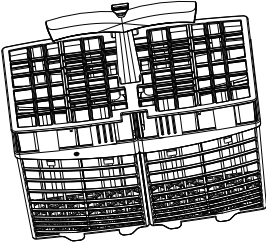

Use the basket to secure cutlery and utensils. Insert cutlery and utensils into the basket to secure.

Disconnect the dishwasher from the power supply and allow it to cool before undertaking any cleaning or maintenance.

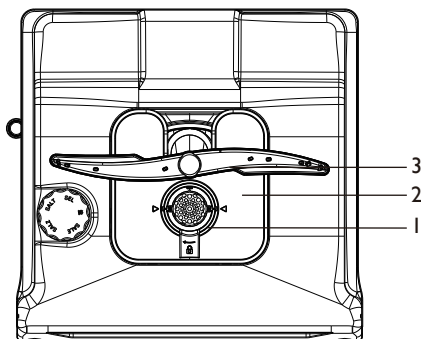

Features

- 1 Filter
 - 2 Filter plate
 - 3 Lower spray arm
- Not shown: top and upper spray arms

Cleaning surfaces

Wipe with a damp cloth and dry using a lint-free cloth. We do not recommend using the following cleaning aids as they may damage the surfaces:

- Plastic or stainless steel scouring pads
- ▶ Abrasive, solvent, household cleaners
- ▶ Acid or alkaline cleaners

- Hand washing liquids or soap
- ▶ Stainless steel cleaners or polishes
- ▶ Laundry detergents or disinfectants

Cleaning the filter, spray arms and filter plate

We recommend that the drain filter and filter plate are removed and cleaned once a month or whenever there is evidence of food particles. The spray arms in normal use should require cleaning less frequently. Lower and upper spray arms can be shaken to remove any foreign material, cleaned in hot water, then rinsed in clean water.

The dishwasher must be used with the filter plate, drain filter and spray arms correctly in place. If using a dishwasher cleaner or descaler, refer to manufacturer instructions.

Extended periods of disuse

If your dishwasher is not going to be used for some time we recommend turning off the power and water supply, leaving it clean and empty with the door ajar. When using your dishwasher for the first time after a long period away, we recommend pouring 3 cups of water into the dishwasher before use. This helps lubricate components that may have dried out during disuse.

Removing and cleaning the filter

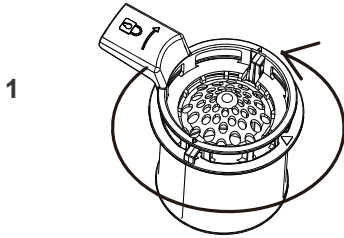

Twist the filter anti-clockwise to release. Lift to remove.

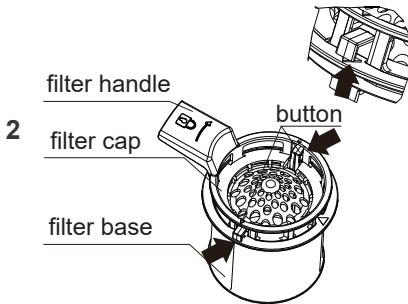

Twist the filter handle anti-clockwise to release. Lift to remove from the filter plate. Separate the filter cap from the base by pressing the release buttons and lifting. Remove the filter plate gently from the locating clips at the rear of the drain. Do not attempt to remove the filter by force as this may cause damage. Clean under hot water and rinse thoroughly.

Replacing the filters:

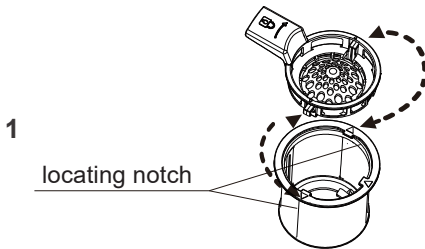

1. Align the filter cap with the notch on the filter base for one side.
2. Press the button to clip the filter cap under the filter base locating notches for the other sides.
3. Slot the filter plate under the locating clips at the rear of the drain and push firmly back into the clips. Ensure the filter plate is flush with the dishwasher base.
4. Place the drain filter back into the dishwasher base. Rotate the filter handle clockwise to click into place.

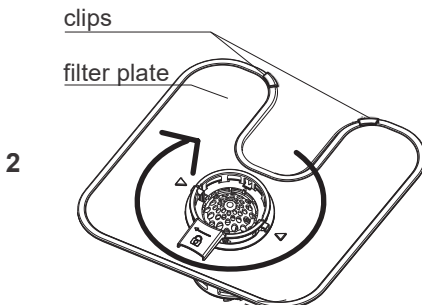

Place the drain filter back into the dishwasher base. Rotate 2 clockwise to click into place.

Removing and cleaning the filter plate

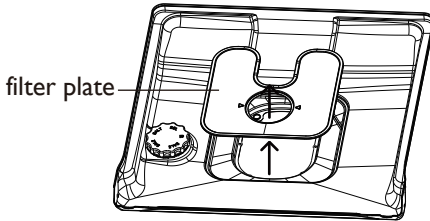

With the filter removed, carefully lift the filter plate up and out.
Clean under hot water and rinse thoroughly.

Replacing the filter plate

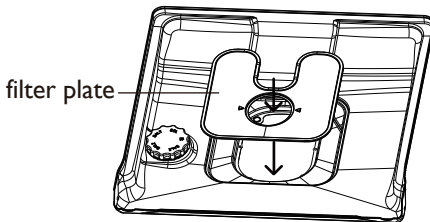

Slot the filter plate under the locating clips at the rear of the drain and push firmly back into place. Ensure the filter plate is flush with the dishwasher base.

Cleaning the top spray arm

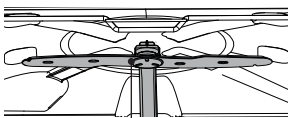

top spray arm

Do not remove the top spray arm for cleaning. Clean with a small, plastic-bristled brush. If heavily soiled or blocked use a dishwasher cleaner/descaler. Follow the manufacturer's instructions.

Cleaning the upper spray arm

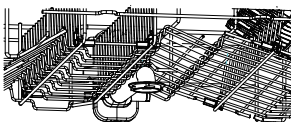

locking nut
upper spray arm

To remove the upper spray arm, turn the locking nut clockwise to release. Rinse the spray arm thoroughly under running water, then refit.

Cleaning the lower spray arm

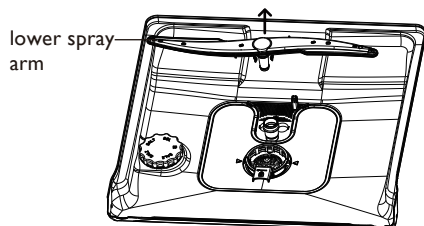

To remove the lower spray arm, lift it from the base of the dishwasher.
Rinse the spray arm thoroughly under running water, then refit.
Ensure the arm rotates freely when refitted.

Winterizing (cold climates)

If the Dishwasher is installed in a cold climate where temperatures fall below zero, we recommend winterizing.

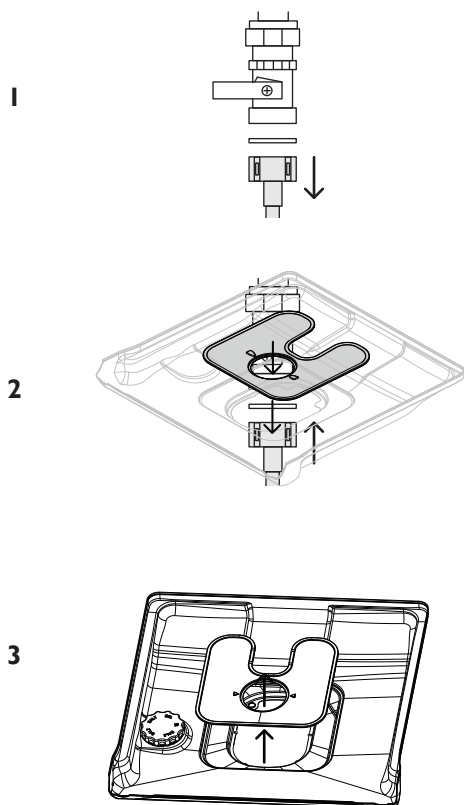

Turn off the water supply.
Disconnect the drain hoses from the sink drain pipe and the water inlet pipe from the water valve.

Drain the water from the hoses, inlet pipe and water valve, using a bucket or pan to collect the water.
Reconnect the water inlet pipe to the water valve and hoses to the sink drain pipe.

Remove the drain filter and the filter plate.
Use a sponge to remove any remaining water from underneath before replacing.

Problem	Possible cause	What to do
Dishwasher will not start	No power.	Ensure the dishwasher is plugged in and the power supply is turned on at the wall.
	The door is not properly closed.	Close the door.
	> <small>reset 3"</small> has not been pressed.	Press > <small>reset 3"</small> .
	Water tap not turned on.	Ensure water is connected and turned on.
Lower spray arm rotates with difficulty	Blocked strainer in water inlet hose.	Check the strainer and clean if necessary – it is located where the water inlet hose screws into the tap.
	Spray arm holes are blocked by small items or food particles.	Clean the spray arm. Refer to 'Maintenance' for instructions.
Cover of detergent dispenser cannot be closed	Detergent compartment has been overfilled.	Remove detergent until the cover can be closed.
	Detergent dispenser is clogged with remnants of detergent.	Wipe dispenser out with a damp cloth. Dry the dispenser before adding detergent.
Remnants of detergent stuck inside dispenser	Compartment was damp when filled with detergent.	Wipe dispenser out with a damp cloth. Dry the dispenser before adding detergent.
	Utensils are blocking the detergent dispenser from opening.	Ensure there are no large utensils positioned in a way that will stop the dispenser cover from opening when the dishwasher door is closed.
Water remains inside dishwasher after wash has ended	Blocked drain connection.	Check that drain connection is free from blockages.
	Drain hose is crimped, bent, or blocked.	Check the drain hose and straighten if needed.
	Pump is jammed.	Call your Haier Authorised Service Centre or Customer Care.
	Filter(s) blocked.	Clean the filter(s). See 'Maintenance' for instructions.
Display flashing while Keylock is on	This is normal. The display remains on although the buttons are disabled.	No action required.

Problem	Possible cause	What to do
Foaming	Incorrect amount or type of detergent used.	Refer to 'Detergent' or consult the detergent manufacturer's instructions.
	Too much egg in the wash load.	Increase the amount of detergent.
	Rinse aid dosage level too high.	Decrease the rinse aid dosage.
	Rinse aid spills not wiped up.	Ensure that all rinse aid spills are wiped up when they occur.
Knocking or rattling sound during wash	Spray arm knocking against dishes.	Pause the wash and rearrange dishes. Refer to 'Setting a wash' and 'Loading suggestions'.
	Dishes have been stacked incorrectly.	
Unclean dishes	Unsuitable wash program for load selected.	Select the appropriate wash program for the load. Refer to 'Wash programs'.
	Soils were too heavily baked on.	Dishes may need soaking.
	Spray arm(s) unable to rotate.	Ensure no items are obstructing the spray arm path.
	Basket/rack incorrectly loaded.	Refer to 'Loading suggestions'.
	Filter plate or filter incorrectly installed.	Refer to 'Maintenance'.
	Detergent put in the wrong compartment.	Refer to 'Wash programs' and 'Detergent'.
	Excessive food not removed from dishes before loading.	Scrape all food scraps off dishes before loading.
	Unsuitable detergent.	Only use powdered or tablet detergent designed for domestic dishwashers.
	Not enough detergent.	Refer to 'Detergent' for recommended quantities. You may need to adjust these to suit your particular load and the hardness of your water supply.
	Spray arm holes are blocked.	Clean the spray arm(s). Refer to 'Maintenance' for instructions.
The filters are blocked.	Clean the filters. Refer to 'Maintenance' for instructions.	

Problem	Possible cause	What to do
Plastic items are discoloured (e.g. stain left by tomato sauce)	Not enough detergent, not pre-rinsed.	Pre-rinse plastic dishes before placing in the dishwasher and/or add more detergent. Alternatively, using the Rinse program after adding dishes may minimise staining.
The dishwasher stops suddenly during the wash	Power or water supply has been interrupted.	Check the power and water supplies.
White stains are left on dishes glasses ; have a milky appearance	Not enough detergent.	Refer to 'Detergent' for recommended quantities. You may need to adjust these to suit the hardness of your water supply.
	Rinse aid dosage too low.	Increase rinse aid dosage. Refer to 'Rinse aid'.
	Rinse aid dosage too low.	Increase rinse aid dosage. Refer to 'Rinse aid'.
Dishes, cutlery have not dried	Items removed too soon.	After the end of the wash program, leave the door ajar and wait for several minutes to help drying.
	Rinse aid dispenser empty. (The rinse aid indicators are lit.)	Add rinse aid. Refer to 'Rinse aid'.
Glasses have dull appearance	Rinse aid dosage too low.	Increase rinse aid dosage. Refer to 'Rinse aid'.
Tea stains or traces of lipstick have not been completely removed	Not enough detergent.	See section 'Detergent' for recommended quantities. You may need to adjust these to suit your particular load.
	Wash temperature too low.	Select a wash program for heavily soiled dishes. Refer to 'Wash programs' for information.
Traces of rust on cutlery	Cutlery is not sufficiently rustproof.	Wash by hand.
Glasses clouded and discoloured; milky coating	Hard water situation.	Increase detergent quantities.
	Glasses are not dishwasher proof.	Wash by hand.

Problem	Possible cause	What to do
Water marks left on glasses and cutlery	Rinse aid level or dosage setting is too low.	Ensure there is rinse aid in dispenser. If necessary, increase the rinse aid setting or try using a wash program with a higher temperature. Refer to 'Rinse aid' for information.
Salt Aid Indicator is lighted.	Softener salt is empty.	Fill the tank up with specific salt until full.

Fault codes

Error codes on the display

Follow the steps below to try and fix the issue.

Problem	Possible cause	What to do
E10 No water	Water tap not turned on.	Ensure the water is connected and turned on. Touch to restart the dishwasher.
	Insufficient water supply pressure.	Check household water pressure.
E30 Leak	Water inlet hose is crimped or bent, so no or not enough water gets to the dishwasher.	Check the water inlet hose and straighten if needed. Touch to restart the dishwasher.
	There are water leakages in the appliance.	Close the water tap.
	The water inlet valve is open and blocked.	Disconnect appliance from power supply.
	The drainage is blocked.	Contact Service.

Wash programme	Eco
Powder detergent quantities	22g main wash
Rinse aid dosage level	R0-R6, R5(default)
Maximum number of place settings	14
Height adjustment of upper basket	Ensure the upper basket is in its lowest position

Recommended loading patterns



Upper basket

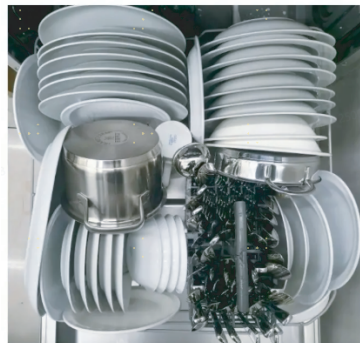

Lower basket

Supplier's name or trade mark:	Candy
Supplier's address ^(b) :	CANDY HOOVER GROUP S.R.L., Via Comolli, 16,Brugherio(MB), 20861, Italy
Model identifier:	CFP 4D9F0W-80/CFP 4D9F0B-80/CFP 4D9F0S/CFP 4D9F0W

General product parameters:

Parameter	Value	Parameter	Value	CFP 4D9F0W-80
Rated capacity ^(a) (ps)	14	Dimensions in cm	Height	84,7
			Width	59,8
			Depth	60,0
EEI ^(a)	49,9	Energy efficiency class ^(a)	[D] ^(c)	
Cleaning performance index ^(a)	1,121	Drying performance index ^(a)	1,061	
Energy consumption in kWh [per cycle], based on the eco programme using cold water fill. Actual energy consumption will depend on how the appliance is used.	0,849	Water consumption in litres [per cycle], based on the eco programme. Actual water consumption will depend on how the appliance is used and on the hardness of the water.	11,0	
Programme duration ^(a) (h:min)	3:58	Type	[freestanding]	
Airborne acoustical noise emissions ^(a) (dB(A) re 1 pW)	49	Airborne acoustical noise emission class ^(a)	[C] ^(c)	
Off-mode (W)	0,50	Standby mode (W)	0,50	
Delay start (W) (if applicable)	4,00	Networked standby (W) (if applicable)	2,00	

Minimum duration of the guarantee offered by the supplier ^(b): 24

Additional information: -

Weblink to the supplier's website, where the information in point 6 of Annex II to Commission Regulation (EU)2019/2022 ⁽¹⁾ ^(b) is found

^(a) for the eco programme.

^(b) changes to these items shall not be considered relevant for the purposes of paragraph 4 of Article 4 of Regulation (EU) 2017/1369.

^(c) if the product database automatically generates the definitive content of this cell the supplier shall not enter these data.

Information to be included in the technical documentation

PARAMETER	UNIT	VALUE
Eco programme energy consumption (EPEC) rounded to three decimal places	kWh/cycle	0,849
Standard programme energy consumption (SPEC) rounded to three decimal places	kWh/cycle	1,700
Energy Efficiency Index (EEI)	—	49,9
Eco programme water consumption (EPWC) rounded to one decimal place	l/cycle	11,0
Cleaning performance index (I _c)	—	1,121
Drying performance index (I _D)	—	1,061
Duration of the eco programme (T _t) rounded to the nearest minute	h:min	4:05
Power consumption in off-mode (P _o) rounded to two decimal places	W	0,50
Power consumption in standby mode (P _{sm}) rounded to two decimal places	W	0,50
Does standby mode include the display of information?	—	No
Power consumption in standby mode (P _{sm}) in condition of networked Standby (if applicable), rounded to two decimal places	W	/
Power consumption in delay start (P _{ds}) (if applicable) rounded to two decimal places	W	4,00
Airborne acoustical noise emissions	dB(A) re 1 pW	49