

Microwave Oven Instructions

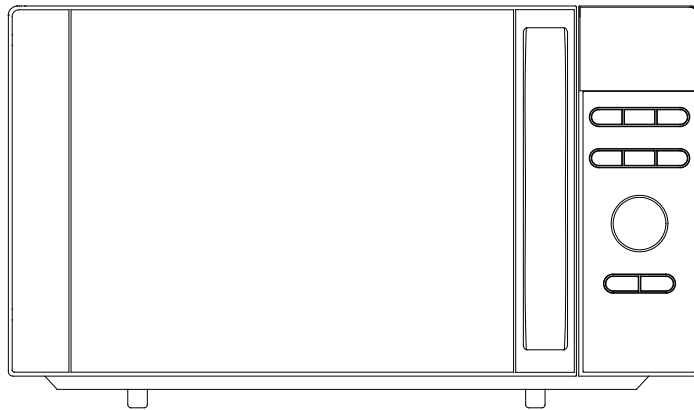

Model: CDW20DSS-UK

DECLARATION OF COMPLIANCE



By placing the CE mark on this product, we are confirming compliance to all relevant European safety, health and environmental requirements which are applicable in legislation for this product.

WASTE MANAGEMENT AND ENVIRONMENTAL PROTECTION



This appliance is labelled in accordance with European Directive 2012/19/EU regarding electric and electronic appliances (WEEE). The WEEE contain both polluting substances (that can have a negative effect on the environment) and base elements (that can be reused.) It's important that the WEEE undergo specific treatments to correctly remove and dispose of the pollutants and recover all the materials. Individuals can play an important role in ensuring that the WEEE do not become an environmental problem; it is essential to follow a few basic rules:

- The WEEE should not be treated as domestic waste;
- The WEEE should be taken to dedicated collection areas managed by the town council or a registered company.

In many countries, domestic collections may be available for large WEEEs. When you buy a new appliance, the old one can be returned to the vendor who must accept it free of charge as a one-off, as long as the appliance is of an equivalent type and has the same functions as the purchased appliance.

PRECAUTIONS TO AVOID POSSIBLE EXPOSURE TO EXCESSIVE MICROWAVE ENERGY

1. Do not attempt to operate this oven with the door open since open-door operation can result in harmful exposure to microwave energy. It is important not to defeat or tamper with the safety interlocks.
2. Do not place any object between the oven front face and the door or allow soil or cleaner residue to accumulate on sealing surfaces.
3. Do not operate the oven if it is damaged. It is very important that the oven door close properly and that there is no damage to the
 - a) Door (including any dents),
 - b) Hinges and latches (broken or loosened),
 - c) Door seals and sealing surfaces.
4. The oven should not be adjusted or repaired by anyone except qualified service personnel.

Content

PRECAUTIONS TO AVOID POSSIBLE EXPOSURE TO EXCESSIVE MICROWAVE ENERGY	2
IMPORTANT SAFETY INSTRUCTIONS	3
Specifications.....	5
Installation Guide	5
GROUNDING INSTRUCTIONS	5
Radio Interference	6
Before Calling For Service	6
Cooking Techniques	6
Cooking Utensils Guide	7
Product Diagram	7
Control Panel	8
Operation Instructions.....	9
Setting clock time	9
Express cooking.....	9
Microwave cooking	9
Speed defrost	9
Auto defrost	9
Multi-stage cooking	9
Child lock	9
Auto cook	9
Cleaning and Care	10

IMPORTANT SAFETY INSTRUCTIONS

When using electrical appliance basic safety precautions should be followed, including the following:

WARNING!--To reduce the risk of burns, electric shock, fire, injury to persons or exposure to excessive microwave energy:

1. Read all instructions before using the appliance and keep for future reference.
2. Use this appliance only for its intended use as described in the manual. Do not use corrosive chemicals or vapors in this appliance. This type of oven is specifically designed to heat, cook or dry food. It is not designed for industrial or laboratory use.
3. Do not operate the oven when empty.
4. Do not operate this appliance if it has a damaged cord or plug, if it is not working properly, or if it has been damaged or dropped. If the supply cord is damaged, it must be replaced by the manufacturer or its service agent or a similarly qualified person in order to avoid a hazard.
5. **WARNING!**--Only allow children to use the oven without supervision when adequate instructions have been given so that the child is able to use the oven in a safe way and understands the hazards of improper use.
6. To reduce the risk of fire in the oven cavity:
 - When heating food in plastic or paper container, check the oven frequently to the possibility of ignition.
 - Remove wire twist-ties from paper or plastic bags before placing bag in oven.
 - If smoke is observed, switch off or unplug the appliance and keep the door closed in order to stifle any flames.
 - Do not use the cavity for storage purposes. Do not leave paper products, cooking utensils, or food in the cavity when not in use.
 - The microwave oven is intended for heating food and beverages. Drying of clothing and heating of warming pads, slippers, sponges, damp cloth and similar may lead to risk of injury, ignition or fire.
7. **WARNING!**--Liquid or other food must not be heated in sealed containers since they are liable to explode.
8. Microwave heating of beverage can result in delayed eruptive boiling, therefore care has to be taken when handle the container.
9. Do not fry food in the oven. Hot oil can damage oven parts and utensils and even result in skin burns.
10. Eggs in their shell and whole hard-boiled eggs should not be heated in microwave ovens since they may explode even after microwave heating has ended.
11. Pierce foods with heavy skins such as potatoes, whole squashes, apples and chestnuts before cooking.
12. The contents of feeding bottles and baby jars should be stirred or shaken and the temperature should be checked before serving in order to avoid burns.
13. Cooking utensils may become hot because of heat transferred from the heated food. Potholders may be needed to handle the utensil.
14. Utensils should be checked to ensure that they are suitable for use in microwave oven.

15. **WARNING!**--It is hazardous for anyone other than a trained person to carry out any service or repair operation which involves the removal of any cover which gives protection against exposure to microwave energy.
16. This Microwave complies with EN 55011/CISPR 11, in this standard it belong to Class B Group 2 classification. Group 2 equipment: group 2 contains all ISM RF equipment in which radio-frequency energy in the frequency range 9 kHz to 400 GHz is intentionally generated and used or only used locally, in the form of electromagnetic radiation, inductive and/or capacitive coupling, for the treatment of material, for inspection/analysis purposes, or for transfer of electromagnetic energy. Class B equipment is equipment suitable for use in locations in residential environments and in establishments directly connected to a low voltage power supply network which supplies buildings used for domestic purposes.
17. This appliance is not intended for use by persons (including children) with reduced physical, sensory or mental capabilities, or lack of experience and knowledge, unless they have been given supervision or instruction concerning use of the appliance by a person responsible for their safety.
18. Children should be supervised to ensure that they do not play with the appliance.
19. The microwave oven is only used in freestanding.
20. **WARNING!**--Do not install oven over a range cook top or other heat-producing appliance. if installed could be damaged and the warranty would be avoid .
21. The microwave oven shall not be placed in a cabinet.
22. The door or the outer surface may get hot when the appliance is operating.
23. Warning: Accessible parts may become hot during use. Young children should be kept away.
24. During use the appliances becomes hot. Care should be taken to avoid Pressing heating elements inside the oven, for cooking ranged and ovens.
25. The temperature of accessible surfaces may be high when the appliance is operating.
26. The appliance shall be placed against a wall.
27. Appliance is not to be used by children or persons with reduced physical, sensory or mental capabilities, or lack of experience and knowledge, unless they have been given supervision or instruction.
28. **WARNING!**--If the door or door seals are damaged, the oven must not be operated until it has been repaired by a competent person.
29. The instructions shall state that appliances are not intended to be operated by means of an external timer or separate remote-control system.
30. The microwave oven is for household use only and not for commercial use.
31. Never remove the distance holder in the back or on the sides, as it ensures a minimum distance from the wall for air circulation.
32. Please secure the turntable before you move the appliance to avoid damages.
33. **CAUTION!**--It is dangerous to repair or maintain the appliance by no other than a specialist because under these circumstances the cover have to be removed which assures protection against microwave radiation. This applies to changing the power cord or the lighting as well. Send the appliance in these cases to our service centre.
34. The microwave oven is intended for defrosting, cooking and steaming of food only.
35. Use gloves if you remove any heated food.
36. Caution! Steam will escape, when opening lids or wrapping foil.

37. This appliance can be used by children aged from 8 years and above and persons with reduced physical, sensory or mental capabilities or lack of experience and knowledge if they have been given supervision or instruction concerning use of the appliance in a safe way and understand the hazards involved. Children shall not play with the appliance. Cleaning and user maintenance shall not be made by children unless they are aged from 8 years and above and supervised.
38. If smoke is emitted, switch off or unplug the appliance and keep the door closed in order to stifle any flames.

Specifications

Power Consumption	230-240V/50Hz, 1200W(microwave)
Output	700W
Operation Frequency	2450MHz
Outside Dimensions	262mm(H)×452mm(W)×353mm(D)
Oven Cavity Dimensions	198mm(H)×315mm(W)×297mm(D)
Oven Capacity	Compact 20Litres
Net Weight	Approx.10.8kg

Installation Guide

1. Make sure that all the packing materials are removed from the inside of the door.
2. **WARNING!**--Check the oven for any damage, such as misaligned or bent door, damaged door seals and sealing surface, broken or loose door hinges and latches and dents inside the cavity or on the door. If there is any damage, do not operate the oven and contact qualified service personnel.
3. This microwave oven must be placed on a flat, stable surface to hold its weight and the heaviest food likely to be cooked in the oven.
4. Do not place the oven where heat, moisture, or high humidity are generated, or near combustible materials.
5. For correct operation, the oven must have sufficient airflow. Allow 20cm of space above the oven, 10cm at back and 5cm at both sides. Do not cover or block any openings on the appliance. Do not remove feet.
6. Do not operate the oven without glass tray, roller support, and shaft in their proper positions.
7. Make sure that the power supply cord is undamaged and does not run under the oven or over any hot or sharp surface.
8. The socket must be readily accessible so that it can be easily unplugged in an emergency.
9. Do not use the oven outdoors.

GROUNDING INSTRUCTIONS

This appliance must be grounded. This oven is equipped with a cord having a grounding wire with a grounding plug. It must be plugged into a wall receptacle that is properly installed and grounded. In the event of an electrical short circuit, grounding reduces risk of electric shock by providing an

escape wire for the electric current. It is recommended that a separate circuit serving only the oven be provided. Using a high voltage is dangerous and may result in a fire or other accident causing oven damage.

WARNING!--Improper use of the grounding plug can result in a risk of electric shock.

Note:

1. If you have any questions about the grounding or electrical instructions, consult a qualified electrician or service person.
2. Neither the manufacturer nor the dealer can accept any liability for damage to the oven or personal injury resulting from failure to observe the electrical connection procedures.

The wires in this cable main are colored in accordance with the following code:

Green and Yellow = EARTH

Blue = NEUTRAL

Brown = LIVE

Radio Interference

Operation of the microwave oven can cause interference to your radio, TV, or similar equipment. When there is interference, it may be reduced or eliminated by taking the following measures:

1. Clean door and sealing surface of the oven.
2. Reorient the receiving antenna of radio or television.
3. Relocate the microwave oven with respect to the receiver.
4. Move the microwave oven away from the receiver.
5. Plug the microwave oven into a different outlet so that microwave oven and receiver are on different branch circuits.

Before Calling For Service

Before asking for service, please check each item below:

- Check to ensure the oven is plugged in securely. If not, remove the plug from the outlet, wait 10 seconds, and plug it in again securely.
- Check for a blown circuit fuse or a tripped main circuit breaker. If these seem to be operating properly, test the outlet with another appliance.
- Check to ensure the control panel is programmed correctly and the timer is set.
- Check to ensure the door is securely closed, engaging the door lock system. If the door is not properly closed, the microwave energy will not flow inside.

IF NONE OF THE ABOVE RECTIFIES THE SITUATION, THEN CONTACT A QUALIFIED TECHNICIAN. DO NOT TRY TO ADJUST OR REPAIR THE OVEN YOURSELF.

Cooking Techniques

1. Arrange food carefully. Place thickest areas towards outside of dish.
2. Watch cooking time. Cook for the shortest amount of time indicated and add more as needed. Food severely overcooked can smoke or ignite.

3. Cover foods while cooking. Covers prevent spattering and help foods to cook evenly.
4. Turn foods over once during microwave cooking to speed cooking of such foods as chicken and hamburgers. Large items like roasts must be turned over at least once.
5. Rearrange foods such as meatballs halfway through cooking both from top to bottom and from the center of the dish to the outside.

Cooking Utensils Guide

1. Microwave cannot penetrate metal. Only use utensils that are suitable for use in microwave ovens. Metallic containers for food and beverages are not allowed during microwave cooking. This requirement is not applicable if the manufacturer specifies size and shape of metallic containers suitable for microwave cooking.
 2. Microwave cannot penetrate metal, so metal utensils or dishes with metallic trim should not be used.
 3. Do not use recycled paper products when microwave cooking, as they may contain small metal fragments which may cause sparks and/or fires.
 4. Round /oval dishes rather than square/oblong ones are recommend, as food in corners tends to overcook.
 5. Narrow strips of aluminum foil may be used to prevent overcooking of exposed areas. But be careful don't use too much and keep a distance of 1 inch (2.54cm) between foil and cavity.
- The list below is a general guide to help you select the correct utensils.

Cookware	Microwave Cooking
Heat-Resistant Glass	Yes
Non Heat-Resistant Glass	No
Heat-Resistant Ceramics	Yes
Microwave-Safe Plastic Dish	Yes
Kitchen Paper	Yes
Metal Tray	No
Metal Rack	No
Aluminum Foil & Foil Containers	No

Product Diagram

1. Door Safety Lock System
2. Oven Window
3. Shaft
4. Roller Ring
5. Control Panel
6. Wave Guide (Please do not remove the mica plate covering the wave guide)
7. Glass Tray

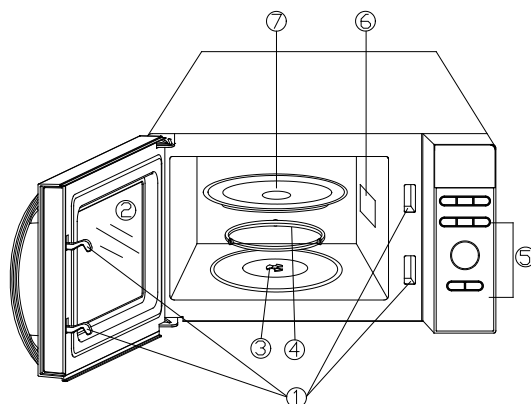

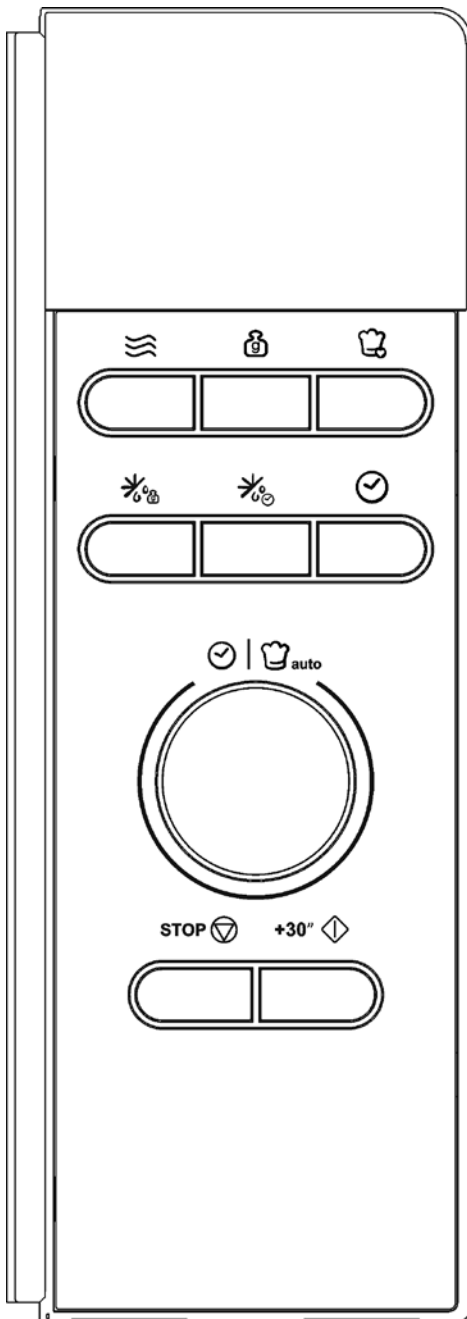

Control Panel





- DISPLAY**

Cooking time, power, action indicators, and clock time are displayed.
-  **POWER**



Press to set microwave cooking power level.
-  **WEI. ADJ.**

Press to specify food weight or number of servings.
-  **MULTI STAGE COOKING**

Use to set a multi-stage cooking program
-  **AUTO DEF.**

Press to program defrost program based on weight.
-  **SPEED DEF.**

Press to set defrost program based on time.
-  **CLOCK**

Use to set the oven clock time.
-  |  **MENU (dial)**

Turn the dial to enter the oven clock time or cooking time.
Turn the dial to select an auto-cooking menu
- STOP**  **STOP/CANCEL**

Press once to temporarily stop cooking, or twice to cancel cooking altogether.
- +30''**  **QUICK START**

Press to start a cooking program.
Simply press it a number of times to begin quick cooking without previously setting power level and cooking time.

Operation Instructions

- When the oven first plugged in, beep will sound and the display will show "🟢" and "1:01"
- In the process of cooking set, broke about 30 seconds the oven will return to standby mode.
- During cooking, if press STOP/CANCEL pad once, the program will be paused, then press START/QUICK START pad to resume, but if press STOP/CANCEL pad twice, the program will be canceled.
- After ending cooking, the screen will display End with sound every two minutes until user press STOP/CANCEL pad or open the door.
- In the process of operation, press a valid button, the buzzer rings once, but if press a invalid button, the buzzer rings twice

Setting clock time

This is a 12 or 24 hour clock. you can choose to set the clock time in 12 or 24 hour cycle by pressing the CLOCK pad in standby mode.

1. In standby mode, press CLOCK pad once or twice to choose 12 or 24 hour clock.
2. Turn TIME/MENU to indicate the hour digit.
3. Press CLOCK pad.
4. Turn TIME/MENU dial to indicate the minute digit.
5. Press CLOCK to confirm the setting.

NOTE: During cooking, you can check the current time of the clock by pressing CLOCK pad.

Express cooking

This feature allows you to start the oven quickly. In standby mode, press the START/QUICK START pad a number of times to set the cooking time, the oven starts work at full power level immediately. The longest cooking time is 12 minutes.

Microwave cooking

1. Press POWER pad repeatedly to select power level.
2. Turn TIME/MENU clockwise to enter cooking time. The longest time is 60 minutes.
3. Press START/QUICK START pad to confirm.

Select power level by pressing the POWER pad:

Press POWER Pad	Cooking Power (Display)
Once	100% (100)
Twice	80% (80)
3 times	60% (60)
4 times	40% (40)
5 times	20% (20)
6 times	0% (00)

NOTE: During cooking you can check the power level by pressing POWER pad.

Speed defrost

The defrosting power is adjusted automatically once the cooking time is programmed.

1. In standby mode, press SPEED DEF. pad once.

2. Turn TIME/MENU dial to enter the cooking time. The longest time is 60 minutes.
3. Press START/QUICK START pad to confirm.

NOTE: During defrosting program, the system will pause and sound to remind you to turn over the food, after that, press START/QUICK START to resume.

Auto defrost

The time and the defrosting power are adjusted automatically once the weight is programmed. The range weight of frozen food varies between 100g and 1800g.

1. In standby mode press AUTO DEF.pad once.
2. Press WEI. ADJ. repeatedly to enter the food weight.
3. Press START/QUICK START pad to confirm.

NOTE: During defrosting program, the system will pause and sound to remind you to turn over the food, after that, press START/QUICK START to resume.

Multi-stage cooking

Your oven can be programmed for up to 2 automatic cooking sequences.

Suppose you want to set the following cooking program:

Microwave-cooking



Microwave-cooking (with lower power level)

1. Open the door and place the food into the oven, close it.
2. Input the first stage of microwave cooking program.
3. Press MULTI STAGE COOKING pad.
4. Input the second stage of microwave cooking program.
5. Press START/QUICK START pad.

NOTE: Speed defrost, auto defrost and auto cook menus cannot be in a multistage cooking program.

Child lock

Use to prevent unsupervised operation of the oven by little children.

To set the child proof lock: In standby mode, if there is not any operation within one minute, the oven will auto enter child lock mode and the lock indicator light will turn on. In the lock state, all buttons are disabled.

To cancel the child proof lock: In child lock mode, open or close the oven door to cancel the program and the lock indicator light will turn off.

Auto cook

For food or the following cooking mode, it is not necessary to program the duration and the cooking power. It is sufficient to indicate the type of food that you wish to cook as well as the weight or servings of the food.

1. In standby mode, turn TIME/MENU dial to select food code.
2. Press WEI. ADJ. repeatedly to indicate the food weight or servings.
3. Press START/QUICK START pad to confirm.

Auto cook menus:

Code	Food	Note:
1	Milk/Coffee (200ml/cup)	<ol style="list-style-type: none">1. For Milk/Coffee and Potato, the display will show numbers of servings instead of weight when press WEI. ADJ. pad.2. The result of auto cooking depends on factors such as the shape and size of food, your personal preference as to the doneness of certain foods and even how well you happen to place food in the oven. If you find the result at any rate not quite satisfactory, please adjust the cooking time a little bit accordingly.
2	Rice (g)	
3	Spaghetti (g)	
4	Potato (230g/serving)	
5	Auto Reheat (g)	
6	Fish (g)	
7	Pizza (g)	
8	Popcorn (100g)	

Cleaning and Care

1. Turn off the oven and unplug the power cord from the wall when cleaning.
2. Keep the inside of the oven clean. When food splatters or spilled liquids adhere to oven walls, wipe with a damp cloth. Mild detergents may be used if the oven gets very dirty. Avoid using spray or other harsh cleaners. They may stain, streak or dull the door surface.
3. The outside of the oven should be cleaned with a damp cloth. To prevent damage to the operating parts inside the oven, water should not be allowed to seep into the ventilation openings.
4. Wipe the door and window on both sides, the door seals and adjacent parts frequently with a damp cloth to remove any spills or spatters. Do not use abrasive cleaner.
5. A steam cleaner is not be used.
6. Do not allow the control panel to become wet. Clean with a soft, damp cloth. When cleaning the control panel, leave oven door open to prevent oven from accidentally turning on.
7. If steam accumulates inside or around the outside of the oven door, wipe with a soft cloth. This may occur when the microwave oven is operated under high humidity condition. And it is normal.
8. It is occasionally necessary to remove the glass tray for cleaning. Wash the tray in warm sudsy water or in a dishwasher.
9. The roller ring and oven floor should be cleaned regularly to avoid excessive noise. Simply wipe the bottom surface of the oven with mild detergent. The roller ring may be washed in mild, soapy water or in a dishwasher. When removing the roller ring, be sure to replace it in the proper position.
10. Remove odors from your oven by combining a cup of water with the juice and skin of one lemon in a microwaveable bowl. Microwave for 5 minutes. Wipe thoroughly and dry with a soft cloth.
11. If the light bulb burns out, please contact customer service to have it replaced.
12. The oven should be cleaned regularly and any food deposits should be removed. Failure to maintain the oven in a clean condition could lead to deterioration of surface that could adversely affect the life of the unit and could possibly result in a hazardous situation.
13. Please do not dispose of this appliance into the domestic rubbish bin; it should be disposed to the particular disposal center provided by the municipalities.

The user manual can also be check and download from our website: www.XXXXX.com